



Зип Общепит

vsezip.ru

+7(812)987-08-81



GAS COMPONENTS



ELECTRIC COMPONENTS



WATER TECHNOLOGY



MECHANICAL COMPONENTS



TOOLS

Spare parts suitable for

GGF

Find the complete and up-to-date range of products in our GEV Webshop

Зип Общепит

vsezip.ru

+7(812)987-08-81

Manufacturer catalogue

The most important spare parts and accessories arranged clearly for every manufacturer



Complete product range and all appliance data always up to date in the GEV Webshop



Alphabetical Index at the end of the catalogue







GEV Webshop

www.gev-online.co.uk

www.gev-online.com







-  Add to Favourites
-  Sign In with email address and usual password
-  Easy-order – place several items in your basket at the same time
-  Quick Item search – no login needed





heating elements

heating elements for pizza ovens







GEV No.	416836	Ref. No.	RESIS008
description	heating element 1000W 230V L 700mm W 142mm thread 1/4" mounting distance 133mm connection length 93mm connection male faston 6.3mm tube ø 8.5mm heating circuits 1 dry heating element 2 hole fixing		
For models:	FM44		
accessories for	416836		
	GEV No.	361182	Ref. No. —
	nut thread 1/4" H 5mm nickel-plated brass WS 17 Qty 1 pcs		
	GEV No.	510417	Ref. No. —
	flat gasket fibre ED ø 20mm ID ø 14mm thickness 2mm Qty 1 pcs		
	GEV No.	520228	Ref. No. —
	tooth lock washer ID ø 15.3mm ED ø 24mm steel Qty 1 pcs for thread M14		
	GEV No.	550262	Ref. No. —
	flat gasket copper ED ø 20mm ID ø 14mm thickness 2mm		







GEV No.	416841	Ref. No.	RESIS002
description	heating element 1100W 230V L 375mm W 255mm L1 20mm L2 80mm L3 275mm W1 50mm W2 155mm thread 1/4" mounting distance 147mm connection length 67mm connection male faston 6.3mm windings 2 tube ø 8.5mm heating circuits 1 dry heating element 2 hole fixing		
accessories for	416841		
	GEV No.	361182	Ref. No. —
	nut thread 1/4" H 5mm nickel-plated brass WS 17 Qty 1 pcs		
	GEV No.	510417	Ref. No. —
	flat gasket fibre ED ø 20mm ID ø 14mm thickness 2mm Qty 1 pcs		
	GEV No.	520228	Ref. No. —
	tooth lock washer ID ø 15.3mm ED ø 24mm steel Qty 1 pcs for thread M14		
	GEV No.	550262	Ref. No. —
	flat gasket copper ED ø 20mm ID ø 14mm thickness 2mm		







GEV No.	416839	Ref. No.	RESIS010
description	heating element 1500W 230V L 1062mm W 141mm thread 1/4" mounting distance 132mm connection length 95mm connection M5 tube ø 8.5mm heating circuits 1 dry heating element 2 hole fixing		
accessories for	416839		
	GEV No.	361182	Ref. No. —
	nut thread 1/4" H 5mm nickel-plated brass WS 17 Qty 1 pcs		

accessories for	416839		
	GEV No.	510417	Ref. No. —
	flat gasket fibre ED ø 20mm ID ø 14mm thickness 2mm Qty 1 pcs		
	GEV No.	520228	Ref. No. —
	tooth lock washer ID ø 15.3mm ED ø 24mm steel Qty 1 pcs for thread M14		
	GEV No.	550262	Ref. No. —
	flat gasket copper ED ø 20mm ID ø 14mm thickness 2mm		

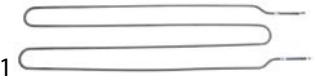

GEV No.	416837	Ref. No.	RESIS009
description	heating element 1500W 230V L 700mm W 270mm L1 30mm L2 70mm L3 600mm W1 174mm W2 148mm thread 1/4" mounting distance 40mm connection length 108mm connection M5 windings 2 tube ø 8.5mm heating circuits 1 dry heating element 2 hole fixing		
spare parts for	416837		
	GEV No.	510417	Ref. No. —
	flat gasket fibre ED ø 20mm ID ø 14mm thickness 2mm Qty 1 pcs		
accessories for	416837		
	GEV No.	361182	Ref. No. —
	nut thread 1/4" H 5mm nickel-plated brass WS 17 Qty 1 pcs		
	GEV No.	520228	Ref. No. —
	tooth lock washer ID ø 15.3mm ED ø 24mm steel Qty 1 pcs for thread M14		
	GEV No.	550262	Ref. No. —
	flat gasket copper ED ø 20mm ID ø 14mm thickness 2mm		



GEV No.	416640	Ref. No.	RESIS006
description	heating element 1600W 230V L 890mm W 220mm connection length 93mm L1 30mm L3 815mm W1 28mm W2 150mm tube ø 8.5mm heating circuits 1 2 hole fixing dry heating element pizza oven thread 1/4" mounting distance 150mm		
accessories for	416640		
	GEV No.	361182	Ref. No. —
	nut thread 1/4" H 5mm nickel-plated brass WS 17 Qty 1 pcs		
	GEV No.	510417	Ref. No. —
	flat gasket fibre ED ø 20mm ID ø 14mm thickness 2mm Qty 1 pcs		
	GEV No.	520228	Ref. No. —
	tooth lock washer ID ø 15.3mm ED ø 24mm steel Qty 1 pcs for thread M14		
	GEV No.	550262	Ref. No. —
	flat gasket copper ED ø 20mm ID ø 14mm thickness 2mm		



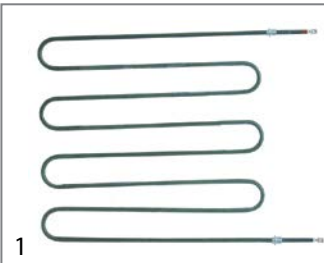

Зип Общепит

vsezip.ru

+7(812)9800000



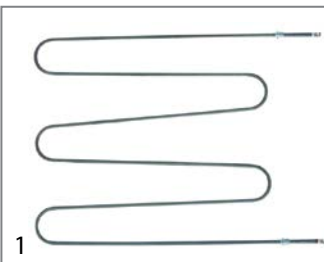

1

GEV No.	416637	Ref. No.	RESIS001
description	heating element 2000W 230V L 470mm W 420mm thread 1/4" mounting distance 412mm connection length 100mm connection M5 tube ø 8.5mm heating circuits 1 dry heating element 2 hole fixing pizza oven		
accessories for	416637		
	GEV No.	361182	Ref. No. —
	nut thread 1/4" H 5mm nickel-plated brass WS 17 Qty 1 pcs		
	GEV No.	510417	Ref. No. —
	flat gasket fibre ED ø 20mm ID ø 14mm thickness 2mm Qty 1 pcs		
	GEV No.	520228	Ref. No. —
	tooth lock washer ID ø 15.3mm ED ø 24mm steel Qty 1 pcs for thread M14		
	GEV No.	550262	Ref. No. —
	flat gasket copper ED ø 20mm ID ø 14mm thickness 2mm		



1

GEV No.	416638	Ref. No.	RESIS003
description	heating element 2100W 230V L 580mm W 460mm thread 1/4" mounting distance 425mm connection length 102mm connection M5 tube ø 8.5mm heating circuits 1 dry heating element 2 hole fixing		
accessories for	416638		
	GEV No.	361182	Ref. No. —
	nut thread 1/4" H 5mm nickel-plated brass WS 17 Qty 1 pcs		
	GEV No.	510417	Ref. No. —
	flat gasket fibre ED ø 20mm ID ø 14mm thickness 2mm Qty 1 pcs		
	GEV No.	520228	Ref. No. —
	tooth lock washer ID ø 15.3mm ED ø 24mm steel Qty 1 pcs for thread M14		
	GEV No.	550262	Ref. No. —
	flat gasket copper ED ø 20mm ID ø 14mm thickness 2mm		



1

GEV No.	416840	Ref. No.	RESIS011
description	heating element 2200W 230V L 1060mm W 260mm L1 35mm L2 85mm L3 910mm W1 50mm W2 160mm thread 1/4" mounting distance 132mm connection length 94mm connection M5 windings 2 tube ø 8.5mm heating circuits 1 dry heating element 2 hole fixing		
accessories for	416840		
	GEV No.	361182	Ref. No. —
	nut thread 1/4" H 5mm nickel-plated brass WS 17 Qty 1 pcs		
	GEV No.	510417	Ref. No. —
	flat gasket fibre ED ø 20mm ID ø 14mm thickness 2mm Qty 1 pcs		
	GEV No.	520228	Ref. No. —
	tooth lock washer ID ø 15.3mm ED ø 24mm steel Qty 1 pcs for thread M14		
	GEV No.	550262	Ref. No. —
	flat gasket copper ED ø 20mm ID ø 14mm thickness 2mm		

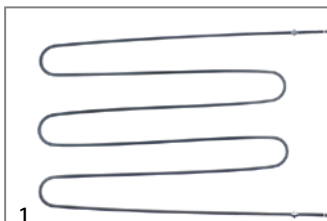

1

GEV No.	420041	Ref. No.	RESIS013
description	heating element 3000W 230V L 690mm W 460mm thread 1/4" mounting distance 452mm connection M5 tube ø 8.5mm heating circuits 1 for pizza oven mounting pos. upper/lower		
For models:	X4-36, X44-36		



1

GEV No.	416639	Ref. No.	RESIS004
description	heating element 3600W 230V L 585mm W 800mm thread 1/4" mounting distance 792mm connection length 100mm connection M5 tube ø 8.5mm heating circuits 1 dry heating element 2 hole fixing pizza oven		



1

GEV No.	419051	Ref. No.	RESIS012
description	heating element 800W 230V L 880mm W 80mm thread 1/4" mounting distance 75mm connection length 120mm connection screw tube ø 8.5mm heating circuits 1 dry heating element 2 hole fixing		

thermostats

control and safety thermostats

EGO

control thermostats

55.10/19_series



1

GEV No.	375247	Ref. No.	TERMO01
description	thermostat t.max. 500°C temperature range 75-500°C 1-pole 1NO 16A probe ø 4mm probe L 228mm capillary pipe 900mm capillary pipe isolatedmm gland nut shaft ø 6x4.6mm shaft L 23mm shaft position upper rotation 270°		
For models:	X4-36, X44-36		

55.34_series



1

GEV No.	375132	Ref. No.	thermo003 old version2
description	thermostat t.max. 500°C temperature range 50-500°C 3-pole 3NO 16A probe ø 4mm probe L 228mm capillary pipe 1200mm capillary pipe isolatedmm gland nut shaft ø 6x4.6mm shaft L 23mm shaft position upper rotation 270°		

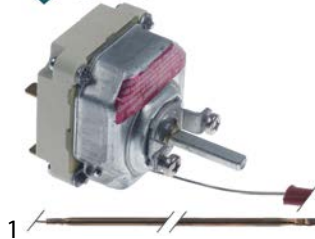

1

GEV No.	375498	Ref. No.	TERMO002 TERMO002+MANOP003 TERMO003
description	thermostat t.max. 512°C temperature range 60-512°C 3-pole 3NO 16A probe ø 3.8mm probe L 225mm capillary pipe 1150mm capillary pipe isolated 1110mm gland nut shaft ø 6x4.6mm shaft L 32mm shaft position upper rotation 270°		

Зип Общепит

control thermostats



1

GEV No.	375103	Ref. No.	thermo003 old Version1
description	thermostat t.max. 500°C temperature range 20-500°C 3-pole 3CO 16A probe ø 8mm probe L 155mm capillary pipe 1000mm capillary pipe isolatedmm gland nut shaft ø 6x4.6mm shaft L 17mm rotation 270°		

switches and momentary switches

rocker/momentary rocker switches

30x11mm



1

GEV No.	345382	Ref. No.	INTER001
description	rocker switch mounting measurements 30x11mm green 1NO/ indicator light 250V 16A 0-1 connection male faston 6.3mm ambient temperature max. 85°C protection IP40		
For models:	X4-36, X44-36		

rotary switches

BREMAS

A1200 series



1

GEV No.	345775	Ref. No.	unbekannt
description	rotary switch 12A 2 operating positions 1-pole		



1

GEV No.	345547	Ref. No.	unbekannt
description	rotary switch sets of contacts 1 2 0-1 type CA0120001 380V 12A shaft ø 5x5mm shaft L 23mm shaft square connection screw		



lamps

indicator lights

indicator lights 2-piece (lens and indicator lamp)

indicator lamps for socket type SA / SC / SD / SF / SR



1

GEV No.	359520	Ref. No.	LAMPA002
description	indicator lamp 400V green connection cable 400mm cable material silicone Qty 1 pcs		
For models:	X4-36, X44-36		

indicator lights (complete)

ø10mm

with screw socket



1

GEV No.	359274	Ref. No.	Lampa spia verde
description	indicator light ø 10mm 400V green		

screw-on/push-on fit

light bulbs

for ovens



1

GEV No.	359448	Ref. No.	LAMPA006
description	light bulb t.max. 500°C socket E14 25W 240V ø 24mm L 54mm lens L 21mm for pizza oven not shock-resistant type		

halogen lamp

for socket GU5.3 / GU10 / GZ5.3



1

GEV No.	357054	Ref. No.	LAMPA003
description	halogen lamp socket GU5.3 12V 20W ø 50mm H 38mm temp.-resist. 300°C AC/DC		

Зип-Общепит

oven lamps

universal oven lamps

mounting diameter 35.5mm



1

GEV No.	359660	Ref. No.	LAMPA010
description	oven lamp mounting ø 35.5mm 230V 25W socket E14 temp.-resist. 300°C connection male faston 6.3mm hard glas		
For models:	X4-36, X44-36		



1

GEV No.	359661	Ref. No.	VETRO002
description	oven lamp glass thread 32.1 ø 58mm hard glas temp.-resist. 350°C		
For models:	X4-36, X44-36		

accessories for 359661



GEV No.	359700	Ref. No.	—
description	gasket for pizza oven fibre glass ID ø 32.5mm ED ø 55mm thickness 5mm		

lamps

light bulbs



1

GEV No.	359448	Ref. No.	LAMPA006
description	light bulb t.max. 500°C socket E14 25W 240V ø 24mm L 54mm lens L 21mm for pizza oven not shock-resistant type		

halogen lamps

for socket GU5,3 / GU10



1

GEV No.	357054	Ref. No.	LAMPA003
description	halogen lamp socket GU5.3 12V 20W ø 50mm H 38mm temp.-resist. 300°C AC/DC		

transformers

open transformers

with plug connection



1

GEV No.	400956	Ref. No.	TRASF001
description	transformer primary 230VAC secondary 12VAC 20VA connection male faston 6.3mm 50/60Hz type T602012/E temperature restriction 150°C ambient temperature max. 80°C		

ignition parts

pilot burners

POLIDORO

pilot burners



1

GEV No.	106899	Ref. No.	PILGA001
description	pilot burner POLIDORO 2 flames natural gas		

electrodes

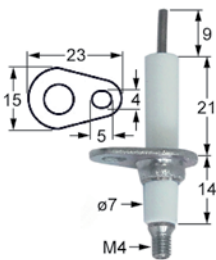

1

GEV No.	100868	Ref. No.	Candele A.O.10
description	ignition electrode flange length 23mm flange width 15mm D1 \varnothing 7mm L1 9mm BL1 21mm BL2 14mm connection M4 fixing dimensions 4x5mm with flange		

3 in 1 Общепит
piezoelectric igniters

mounting diameter 22mm



1

GEV No.	100008	Ref. No.	ERTA 070602
description	piezoelectric igniter body plastic blowing mounting \varnothing 22mm connection \varnothing 2mm cable lengthmm		

ignition bridges

1

GEV No.	105557	Ref. No.	bruc.int.accensi. G9
description	ignition bridge for pizza oven		

1

GEV No.	105556	Ref. No.	bruc.int.accen.G4/G6 BRUGA004
description	pilot burner L 580mm \varnothing 12mm for pizza oven		

gas burners

bar burners

bar burners



1

GEV No.	105554	Ref. No.	bruciatori 0-51 G4 BRUGA001
description	bar burner \varnothing 50mm Wmm Hmm L 520mm flange width 52mm flange \varnothing 75mm pizza oven		



1

GEV No.	105555	Ref. No.	BRUGA002
description	bar burner \varnothing 50mm Wmm Hmm L 800mm flange width 52mm flange \varnothing 75mm 5.2kW pizza oven		

GEV No.	105862	Ref. No.	Bruc. later. G6-G9 BRUGA003
description	bar burner ø 50mm Wmm Hmm L 800mm flange width 52mm flange ø 75mm mounting pos. lateral pizza oven		

equipment-specific units

for vegetable slicers

miscellaneous



GEV No.	110703	Ref. No.	IMPUG001
description	cylindrical handle thread M10 ø 28mm L 87mm		
For models:	X4-36, X44-36		

for cheese graters

miscellaneous



GEV No.	110703	Ref. No.	IMPUG001
description	cylindrical handle thread M10 ø 28mm L 87mm		
For models:	X4-36, X44-36		

for convection ovens/combi-steamers

glass panels



GEV No.	693100	Ref. No.	VETRO001
description	glass panel L 250mm W 100mm thickness 5mm rectangular		

Зип-Общепит
for pizza ovens

glass panels
vsezip.ru

+7(812)987-08-81



GEV No.	693131	Ref. No.	vetro 350x100x5 VETRO004
description	glass panel L 350mm W 100mm thickness 4mm rectangular		



GEV No.	700962	Ref. No.	VETRO005	
description	glass panel L 415mm W 108mm thickness 5mm rectangular for door			
For models:	X4-36, X44-36			
accessories for	700962			
	GEV No.	901400	Ref. No.	GUARN003
	window gasket suitable for GGF L 416mm external weith 113mm Qty 1m thickness 2.5mm			

firebricks



GEV No.	850051	Ref. No.	Piastra refretaria Baby TAVEL007
description	firebrick L 500mm W 500mm H 17mm delivery freight forwarding company only		

Зип Общепит

knobs

vsezip.ru

+7(812)987-08-81

			
1			
GEV No.	850100	Ref. No.	TAVEL015
description	firebrick L 610mm W 305mm H 17mm delivery freight forwarding company only		

 <p>Image not available</p>			
1			
GEV No.	850052	Ref. No.	Piastra refretaria P4
description	firebrick L 610mm W 610mm H 16mm delivery freight forwarding company only		

			
1			
GEV No.	850109	Ref. No.	TAVEL011
description	firebrick L 718mm W 359mm H 17mm delivery freight forwarding company only		
For models:	X4-36, X44-36		

			
1			
GEV No.	850053	Ref. No.	Piastra refretaria P6 TAVEL006
description	firebrick L 915mm W 610mm H 18mm delivery freight forwarding company only		

producer-specific knobs

GGF

			
1			
GEV No.	111468	Ref. No.	MANOP004
description	knob zero mark ø 42mm shaft ø 6x4.6mm shaft flat upper black/red		

handles and hand wheels

cylindrical handles

fixed

			
1			
GEV No.	110703	Ref. No.	IMPUG001
description	cylindrical handle thread M10 ø 28mm L 87mm		
For models:	X4-36, X44-36		

door handles

door handles

			
1			
GEV No.	694308	Ref. No.	MANIG004
description	door handle for pizza oven L 140mm W 78mm handle ø 27.5mm with flange black		

gaskets

gaskets for heated units

window seals

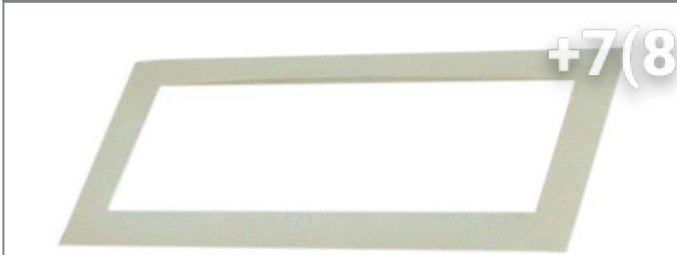

1

GEV No.	693101	Ref. No.	GUARN001
description	window gasket L 250mm W 100mm thickness 5mm		

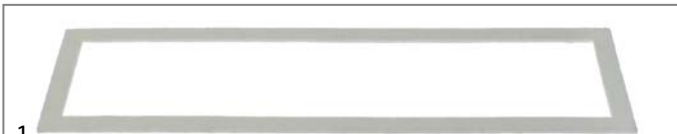

1

GEV No.	696519	Ref. No.	GUARN004
description	window gasket L 355mm W 105mm thickness 3mm		

Зип-Общепит

special gaskets

miscellaneous

vsezip.ru

+7(812)987-08-81

1

GEV No.	901400	Ref. No.	GUARN003
description	window gasket suitable for GGF L 416mm external weith 113mm Qty 1m thickness 2.5mm		
For models:	X4-36, X44-36		

Зип Общепит

vsezip.ru

+7(812)987-08-81

B

bar burners 7

C

control thermostats 5,5

G

gas burners 7

gaskets for heated units 10

H

halogen lamp 6

heating elements 3

heating elements for pizza ovens 3

I

ignition bridges 7

indicator lights 6

indicator lights (complete) 6

L

lamps 6

light bulbs 6

O

oven lamps 6

P

piezoelectric igniters 7

pilot burners 7

R

rocker/momentary rocker switches 5

rotary switches 5

S

switches and momentary switches 5

T

thermostats 5

transformers 7

W

window seals 10